

→ The world around Directive 2014/55/EU

Observations, lessons learned and follow-up Roma, 2/12/2014

Ir. P. Potgieser

Leader for Activity Group '*Standardisation & Interoperability*'
in the European Multistakeholder Forum on e-Invoicing

Disclaimer: This contribution is made as independent expert, not representing any government or organisation. The views expressed in this document are the views of the expert and do not necessarily reflect the views of the state and/or the organisation for which the expert works.

Agenda

- The playing field around 2014/55/EU – reminder
- (EU) Public sector developments
- The what and how of (e-)Invoices
- Observations / Lessons learned
- Next steps
- Questions

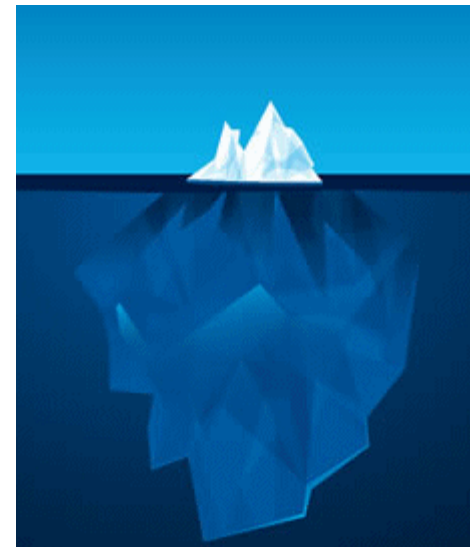

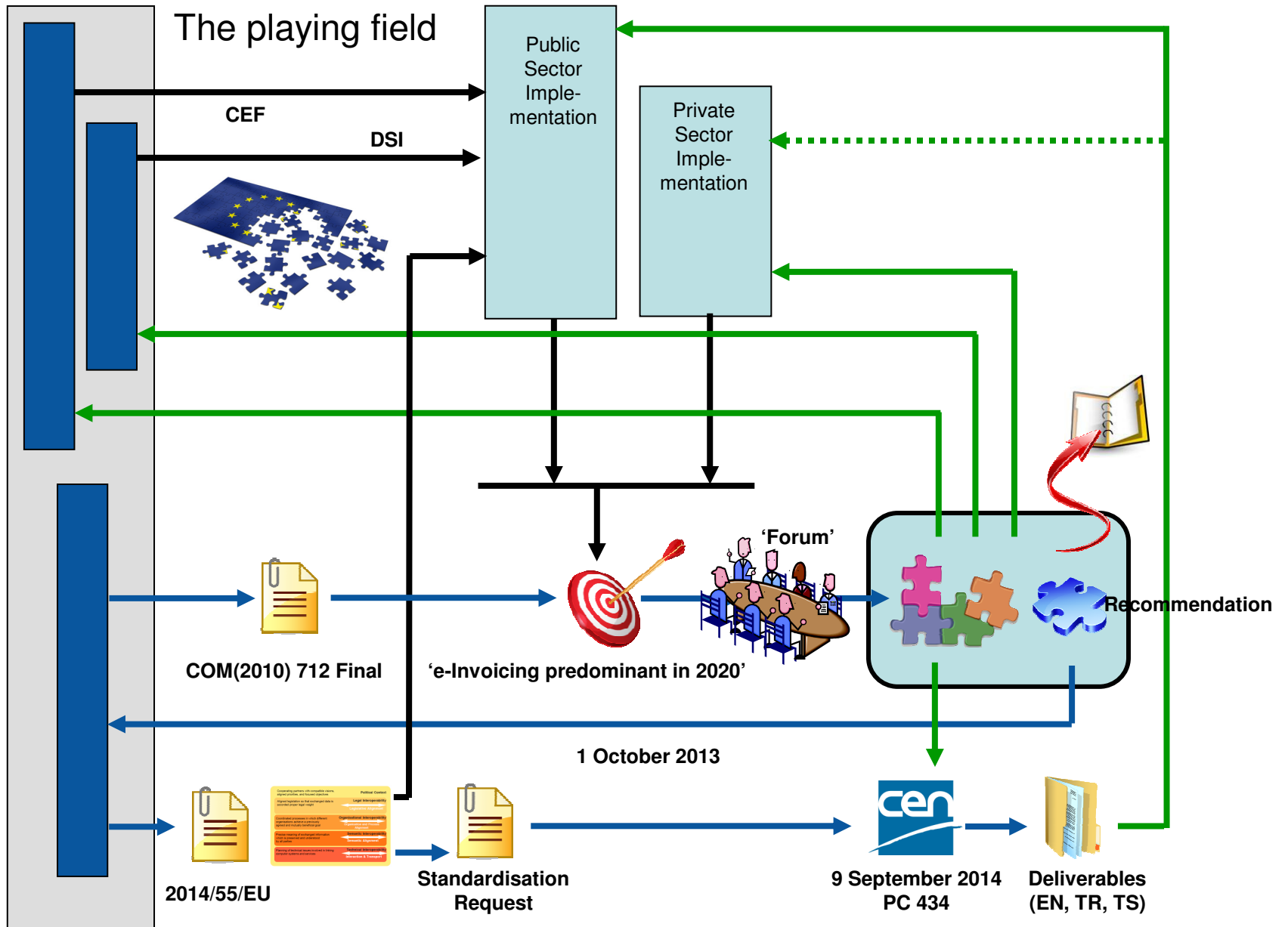

Disclaimer: This contribution is made as independent expert, not representing any government or organisation. The views expressed in this document are the views of the expert and do not necessarily reflect the views of the state and/or the organisation for which the expert works.

(EU) Public Sector developments



*moving
services
forward.eu*

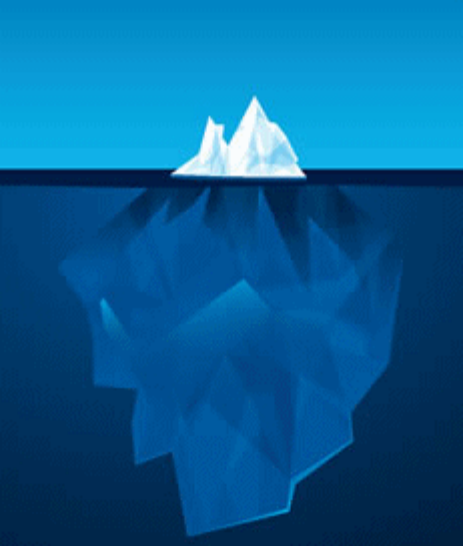

(EU) Public Sector developments



CATALOGUE OF SERVICES

reusable building blocks



(EU) Public Sector developments



eINVOICING



The **eInvoicing** building block **helps** public administrations implement electronic invoicing in compliance with the eInvoicing Directive of the European Parliament and the Council.

The European Committee for Standardization (CEN) will define a new semantic standard for eInvoicing in public procurement and the binding of the resulting standard to a number of existing syntaxes. **Once this building block is deployed**, a supplier's conformity to the semantic standard can be validated prior to sending actual invoices. Also, complementarity with the Pan-European Public Procurement Online (PEPPOL) network is guaranteed.

This means that the eInvoicing solution of CEF provides tools for the public administrations to reduce the efforts for complying with the Directive.

(EU) Public Sector developments



Our solutions

The CEF invoicing solution is a set of tools and services provided by the European Commission complementary to the solution developed by the PEPPOL project. It is compliant with the current specifications of CEN and will follow the new standards which CEN will define.



Several tools and services will be available:

A test infrastructure, which can be used by public administrations to validate a given invoice against the standards

A tool for conversion between the standard syntaxes: it will be possible for the public administrations to support only one of the standard syntaxes and convert others into it.



Online list of standard codes as defined in the European standard



The what and how of (e-)Invoices

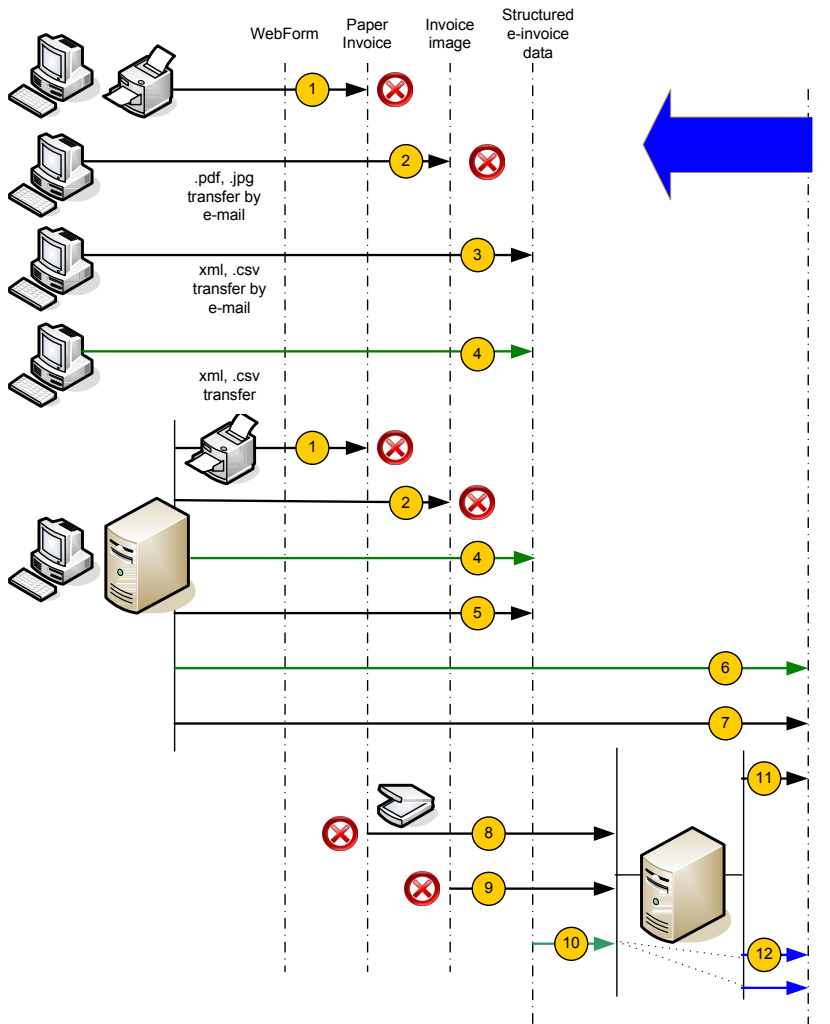

Disclaimer: This contribution is made as independent expert, not representing any government or organisation. The views expressed in this document are the views of the expert and do not necessarily reflect the views of the state and/or the organisation for which the expert works.

The what and how of (e-)Invoices

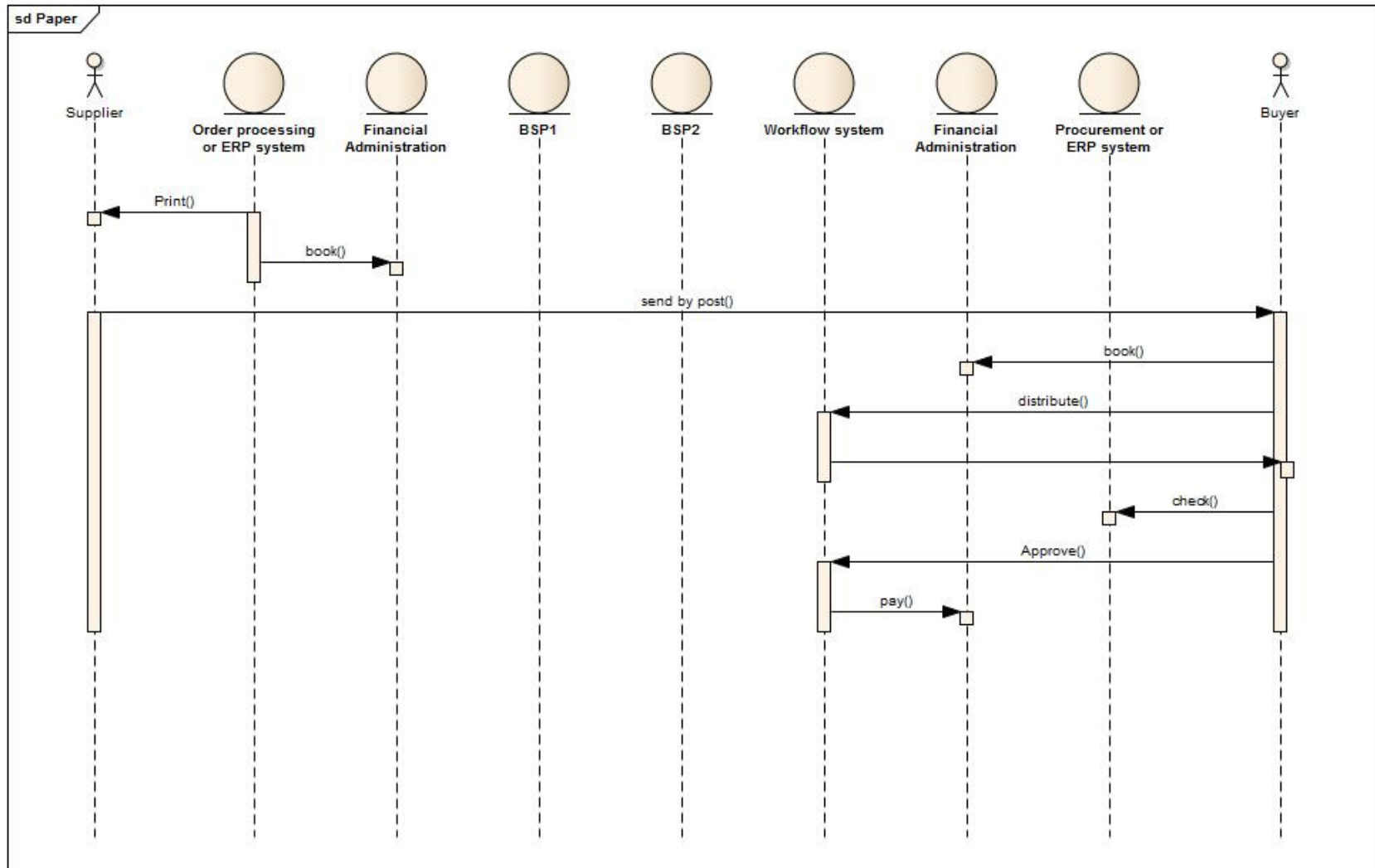

Disclaimer: This contribution is made as independent expert, not representing any government or organisation. The views expressed in this document are the views of the expert and do not necessarily reflect the views of the state and/or the organisation for which the expert works.

Observations / Lessons Learned

- The Recommendation of the Multistakeholder Forum on e-Invoicing ('Forum') was developed into Directive 2014/55/EU.
- The Directive only covers 'e-Invoicing in e-Procurement'
- The uptake is by different bodies, not necessarily under centralised governance
- The potential impact of the Directive is not yet obvious
- C_2014_4142_F1_COMMISSION_DECISION_EN_V9_P1_771390.pdf renewed the mandate of the Forum for another three years, adding and revising tasks
- There are many dimensions to realising the objective from COM (2010) 712 Final and COM (2013) 453 Final '*e-Invoicing predominant in 2020*', including the private sector developments
- Involvement and participation of stakeholders is very relevant



Disclaimer: This contribution is made as independent expert, not representing any government or organisation. The views expressed in this document are the views of the expert and do not necessarily reflect the views of the state and/or the organisation for which the expert works.

Follow up – next steps

- Further develop information in / with the European Multistakeholder Forum on e-Invoicing; including:
 - an overview of CEF, DSI, eSENS, and related matter to provide the background and underpinning for advice and recommendations in this particular area
 - an exploration of available timelines, feedback windows,
- Help develop stakeholder involvement and participation
 - Further create and improve awareness
 - Dissemination of information
 - Participation in development work (e.g. CEN PC 434)
 - In Italy: Commissione UNINFO - "eBusiness e Servizi Finanziari"
(<http://www.uninfo.it/index.php/partecipare/aree/category/ebusiness-servizi-finanziari>)

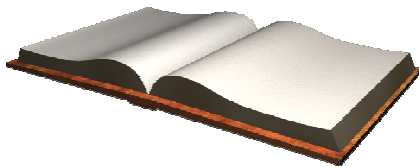

Disclaimer: This contribution is made as independent expert, not representing any government or organisation. The views expressed in this document are the views of the expert and do not necessarily reflect the views of the state and/or the organisation for which the expert works.

Questions

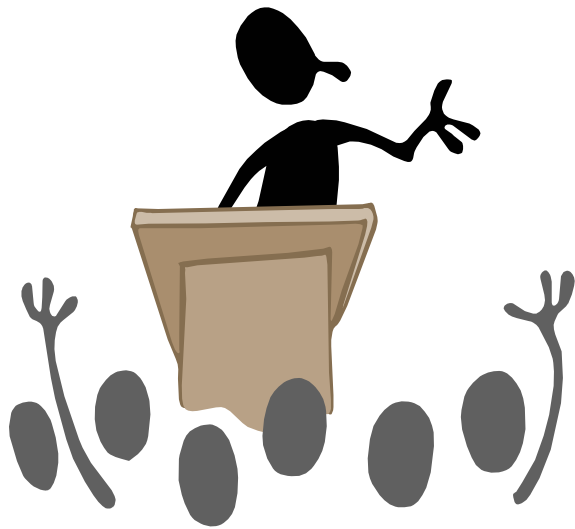

Disclaimer: This contribution is made as independent expert, not representing any government or organisation. The views expressed in this document are the views of the expert and do not necessarily reflect the views of the state and/or the organisation for which the expert works.